SINOPE



SINOPE 28"



USER MANUAL

INDEX

1. FOREWORD	4
1.1 General	4
1.2 Assistance	4
1.3 Graphic form of security warnings	4
2. SAFETY WARNINGS	5
2.1 General safety rules	5
2.2 Responsibilities	5
2.3 Warning for users	6
2.4 Maintenance warnings	6
2.5 Other provisions	7
2.6 Unpacking and tuning	7
2.6.1 Saddle adjustment	7
2.6.2 Pedal mounting	8
3. BICYCLE DESCRIPTION	9
3.1 General description	9
3.2 Data sheet	10
3.3 Brake levers	11
3.4 Speed change	11
3.5 Service system management	12
3.5.1 Service management commands	12
3.5.2 Turning the system on/off	12
3.5.3 Support activation	13
3.5.4 Support level setting	13
3.6 Display graphic interface	14
3.6.1 General screen composition	14
3.7 On-board computer mode	15
3.7.1 Race mode	15
3.7.2 Summary mode	16
3.8 Walking assistance mode	17
3.9 Menu	18
3.9.1 Screen brightness	19
3.9.2 Change language	19
3.9.3 Units of measurement	19
3.9.4 Weight	20
3.9.5 Gender	20
3.10 Error code	20
3.10.1 Troubleshooting	22
3.11 Battery	23
3.11.1 Charge status	23
3.11.2 Battery installation/removal	23
3.11.3 Battery charging	25
3.11.4 Troubleshooting	25
3.12 Front and rear headlight	26
3.13 Front suspension	26
4. CONDITIONS OF USE AND INTENDED ENVIRONMENT	27
4.1 Intended use	27
4.2 Environment of use	28
4.3 Improper uses and contraindications	28
5. LIFTING AND TRANSPORT	29
5.1 Lifting	29
5.2 Transport	29
6. COMMISSIONING	30
6.1 Battery charge	30
6.2 Preliminary functional checks	31
6.2.1 Control devices	31



6.2.2	Wheels	31
6.2.3	Braking system	31
6.2.4	Frame, handlebar and saddle position	32
6.2.5	Brake adjustment	33
6.2.6	Suspension adjustment	33
6.2.7	Headlight operation	33
7.	USE OF THE BICYCLE	34
7.1	Use of the bicycle	35
7.2	Braking	35
7.3	Bicycle parking	35
8.	MAINTENANCE	36
8.1	General	36
8.2	Daily maintenance and checks	36
8.2.1	Control of nameplates and pictograms	36
8.2.2	Wheel control	36
8.2.3	Brake operation control	36
8.3	Weekly maintenance and checks	37
8.3.1	Washing and cleaning	37
8.3.2	Lubrication and chain tension control	37
8.3.3	Frame and bolt control	37
8.4	Monthly maintenance and checks	38
8.4.1	Derailleur control and adjustment	38
9.	TECHINCAL SUPPORT AND SPARE PARTS	39
10.	WAREHOUSE	39
11.	DISPOSAL OF COMPONENTS AND MATERIALS	40
12.	WARRANTY RULES	41
13.	CONFORMITY	42



1. FOREWORD

1.1 General

This manual is an integral and essential part of the pedal-assisted bicycle models E - SINOPE 28". Before commissioning, it is essential that users read, understand and follow the following positions scrupulously.

The manufacturer is not liable for damage caused to persons and / or things or to pedal-assisted bicycles, if they are used incorrectly with respect to the requirements indicated.

With a view to continuous technological development, the manufacturer reserves the right to modify the components, including the frame without notice, without this manual being automatically updated.

1.2 Support

For any inconvenience or request for clarification, contact the authorized dealer, who has competent and specialized personnel, as well as specific equipment and original spare parts.

1.3 Graphic form of safety warnings

To identify the security messages in this manual, the following graphic signal symbols will be used. They have the function of attracting the attention of the reader / user for the purpose of a correct and safe use of the assisted bicycle.



ATTENTION

It highlights behavioral rules to be kept in order to avoid damage to the pedal-assisted bicycle and / or the onset of dangerous situations.



DANGER

Highlights the presence of hazards that cause residual risks to which the user must pay attention in order to avoid accidents or material damage.

2. SAFETY WARNINGS



ATTENTION

USE OF THE PEDAL-ASSISTED BICYCLE

Each user must have first read the instruction manual, in particular the chapter on safety claims.



ATTENTION

RISKS ASSOCIATED WITH THE USE OF THE PEDAL-ASSISTED BICYCLE

- Notwithstanding the application of safety devices, for the safe use of the pedal-assisted bicycle, all the requirements relating to the prevention of accidents reported in this manual.
- Always stay focused while driving and **DO NOT** underestimate the residual risks associated with the use of the assisted bicycle.

2.1 General safety rules

Even if you are already practical in the use of pedal-assisted bicycles, you must follow the instructions given here, in addition to the general precautions to be observed during the driving a motor vehicle. In particular:

- Acquire full knowledge of the pedal-assisted bicycle.
- Read the manual carefully to know the operation, the safety devices and all the precautions necessary for the safe use of the vehicle. All this to allow safe use.
- Carefully keep the pedal-assisted bicycle in perfect condition.

For any inconvenience or request for clarification, contact without hesitation the authorized dealer, who has competent and specialized personnel, specific equipment and original spare parts.

2.2 Responsibilities

Failure to comply with the operating instructions and safety requirements contained in this manual relieves the manufacturer of any liability.

If the maintenance of the pedal-assisted bicycle is carried out in a manner that does not comply with the instructions provided, with non-original spare parts or in any case in such a way as to compromise its integrity or modify its characteristics, the manufacturer will be relieved of any responsibility inherent in the safety of persons and the defective operation of the pedal-assisted bicycle.



**ATTENTION****UNAUTHORIZED CHANGES**

If you hear unusual noises, or feel something strange, stop the pedal-assisted bicycle immediately. Carry out a check afterwards and, if necessary, contact the authorized dealer.

For any data not included or not deductible from this manual it is recommended to consult directly the authorized dealer.

2.3 Warning for users

1. It is forbidden to load a passenger.
2. It can only be used by experienced adults and children.
3. Do not take alcohol or drugs before riding the pedal-assisted bicycle.
4. These models of pedal-assisted bicycles are designed and built to be used outdoors, on roads and private and public environments.
5. Don't ask your pedal-assisted bike for performance that's superior to what it was designed for.
6. Never ride the pedal-assisted bicycle with disassembled parts.
7. Avoid uneven surfaces and obstacles.
8. Ride with both hands on the handlebars.
9. Replace worn and /or damaged parts, check that the protections work correctly before use.

2.4 Maintenance warnings

1. Any maintenance must take place with the battery disconnected.
2. During each maintenance phase, operators must be equipped with the necessary accident prevention equipment.
3. The tools used for maintenance must be suitable and of good quality.
4. Do not use gasoline or flammable solvents as detergents, but always use non-flammable and non-toxic solvents.
5. Limit as much as possible the use of compressed air for cleaning (max 2 bar) and protect yourself with glasses with side guards.
6. Never use open flames as a means of lighting when carrying out verification or maintenance operations.
7. After every intervention of maintenance or regulation make sure who Not Remain paraphernalia or Bodies Strangers between the organs of movement of bicycle a foot thrust Assisted.

**ATTENTION****ORIGINAL SPARE PARTS**

**Use only original spare parts supplied by M.B.M. S.r.l.
Any liability of the Manufacturer for damage or loss of functionality caused as a result of the use of non-original accessories and parts is excluded.**



2.5 Other provisions

The first thing to do when starting the use, is to check the presence and integrity of the protections and the operation of the safety. If you find any defects do not use the pedal-assisted bicycle!



DANGER

GUARDS

It is strictly forbidden, therefore, to modify or remove the guards, controls, labels and indication plates.

2.6 Unpacking and tuning

The pedal-assisted bicycle is delivered fully assembled and working.

2.6.1 Saddle adjustment

The pedal-assisted bicycle is delivered mounted and ready to use. Check the adjustment of the handlebar (which is aligned with the front wheel) of the brake levers, of the saddle, in such a way as to guarantee a comfortable and safe use for the user. The adjustment of the height of the saddle is an essential prerogative for the correct use of the pedal-assisted bicycle. Incorrect adjustment can generate structural breaks to the frame.

Adjust the height of the saddle by operating the quick release mechanism (Ref. A - Figure 1).

Check that the mechanism is tightened before testing the seat and using the medium. Do not lift the saddle beyond the limit sign placed in the tube (Ref. B - Figure 1).

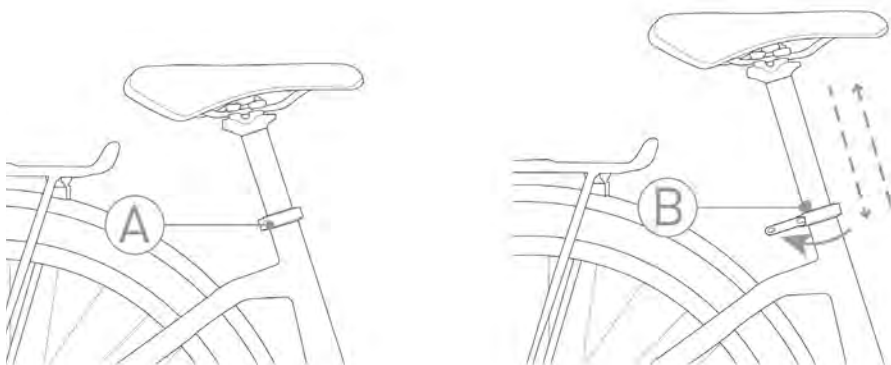

FIG. 1



DANGER

IMPORTANT NOTICE:

For your safety, the sign of retraction of the seatpost (B) should never be outside the tube in which the seatpost is inserted.



ATTENTION

ASSEMBLY

In the event that you do not have the appropriate instrumentation for adjustment or do not have the capabilities contact the authorized riv- enditore .



2.6.2 Pedal mounting

Right Pedal: it is identified by the letter R marked on its pin. For pedal mounting, screw by turning the pin clockwise. (Figure 2)

Left pedal: it is identified by the letter L marked on its pin. For pedal mounting, screw by turning the pin counterclockwise. (Figure 2)



ATTENTION

ASSEMBLY

In the event that you do not have the appropriate equipment for adjustment or do not have the skills contact the authorized dealer.

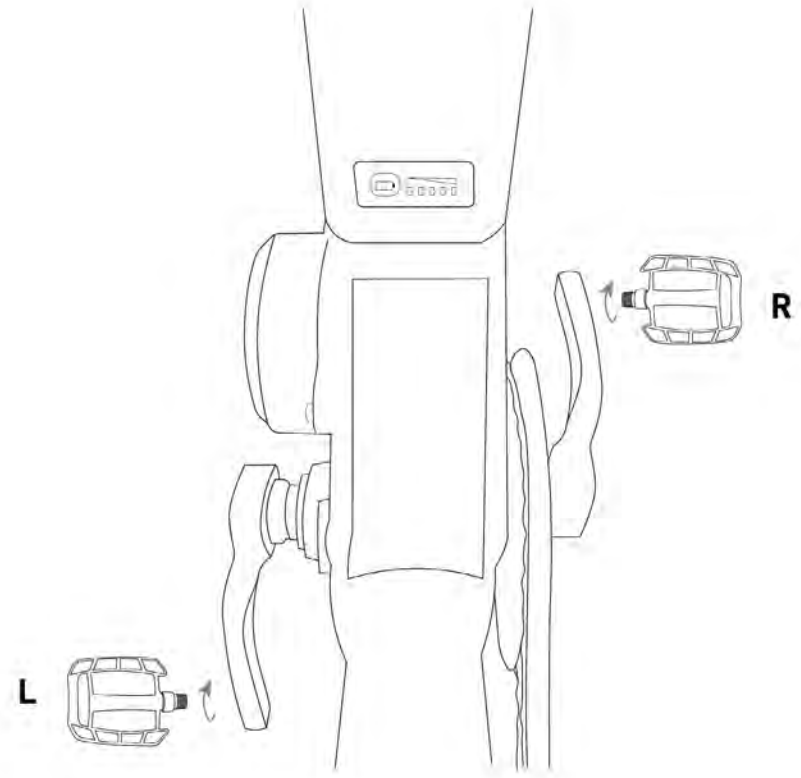

FIG. 2

3. BICYCLE DESCRIPTION

3.1 General description

The pedal-assisted bicycle is designed and built to be used outdoors, on roads and private or public environments. In particular, the components and the type of pedal-assisted bicycle, allow you to face routes with asphalted and unpaved surfaces without particular roughness.



INCORRECT AND UNINTENDED USE

The bicycle has been designed and manufactured for the specified use; a different use and non-compliance with the technical parameters set by the manufacturer, may constitute a dangerous condition for users.

The pedal-assisted bicycle is equipped with a rechargeable battery and an electric motor, whose intervention takes place only in conjunction with the pedaling and gradually stops as the speed of the vehicle approaches 25 km / h, and then stops completely at that speed.

For the management of the assistance system there is a special control located next to the left knob, on the handlebar.

On the right side of the handlebar there is a control system for the selection of gears.



3.2 Data sheet

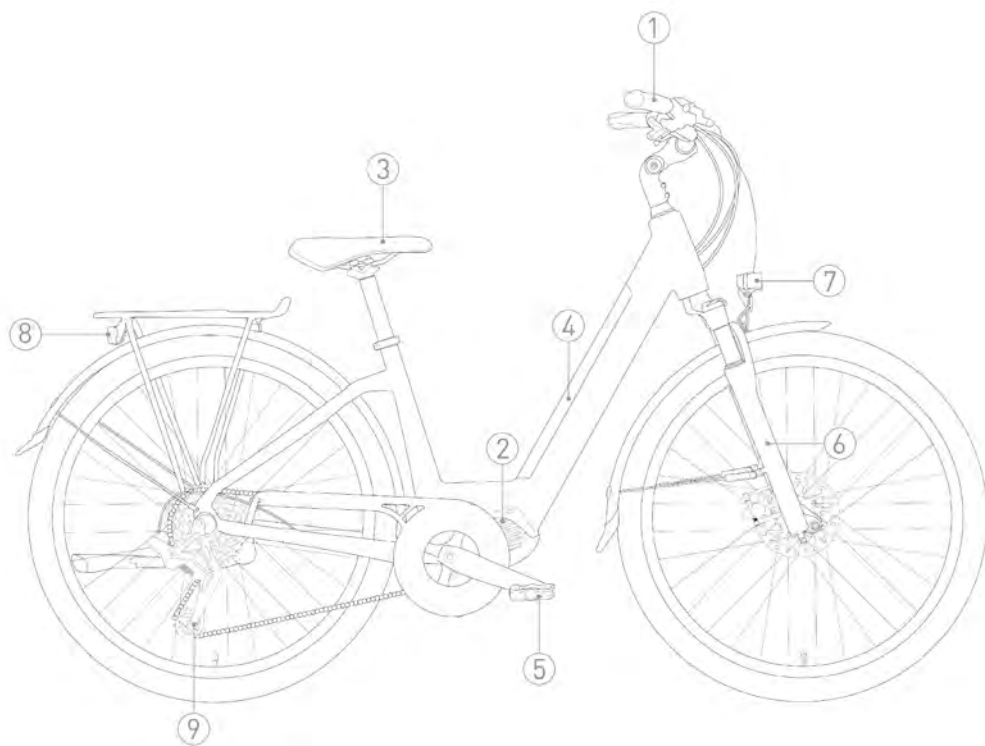

1. HANDLEBARS AND CONTROLS
2. MOTOR
3. SADDLE
4. BATTERY
5. PEDALS
6. FORK
7. FRONT LIGHT
8. REAR LIGHT
9. REAR DERAILLEUR

CODE	E809 DONNA
FRAME	ALUMINIUM HYDROFORMED
FORK	SUSPENSION WITH ADJUSTMENT
CRANKSET	38 TEETH
REAR DERAILLEUR	DEORE
SHIFTER	10 SPEEDS
BRAKES	SHIMANO BR-M315 HYDRAULIC
DISKS	SHIMANO ANT: Ø 180 mm POST: Ø 160 mm
WHEELS	28*2.00
SADDLE	SADDLES ITALIA SPORTOURER
PEDAL	RIGHT AND LEFT NON-SLIP POLYMER MATERIAL
ENGINE	CENTRAL SPORTS OLI 85 NM
BATTERY	PHYLION BN-18, 14 Ah, 504 Wh
SPEED MAX ASSISTANCE	25 KM/H
DISPLAY	LCD
POWER LEVELS	5
WEIGHT	25 KG

3.3 Brake levers

The brake levers (Ref.C - Figure 3) are placed on the handlebars of the pedal-assisted bicycle, near the knobs (Ref. D- Figure 3). These systems make it possible to control the calipers of the brake discs, located near the wheel hubs. The right lever controls the rear brake, the left one the front brake; the braking action is proportional to the force applied on the lever.

3.4 Speed change

The pedal-assisted bicycle has a 10-speed gearbox with the sprockets positioned on the hub of the rear wheel, selectable by means of the opposing levers, located at the base of the right knob. The indicator (Ref. E - Figure 3) at the top of the handlebar allows you to view the selected ratio.

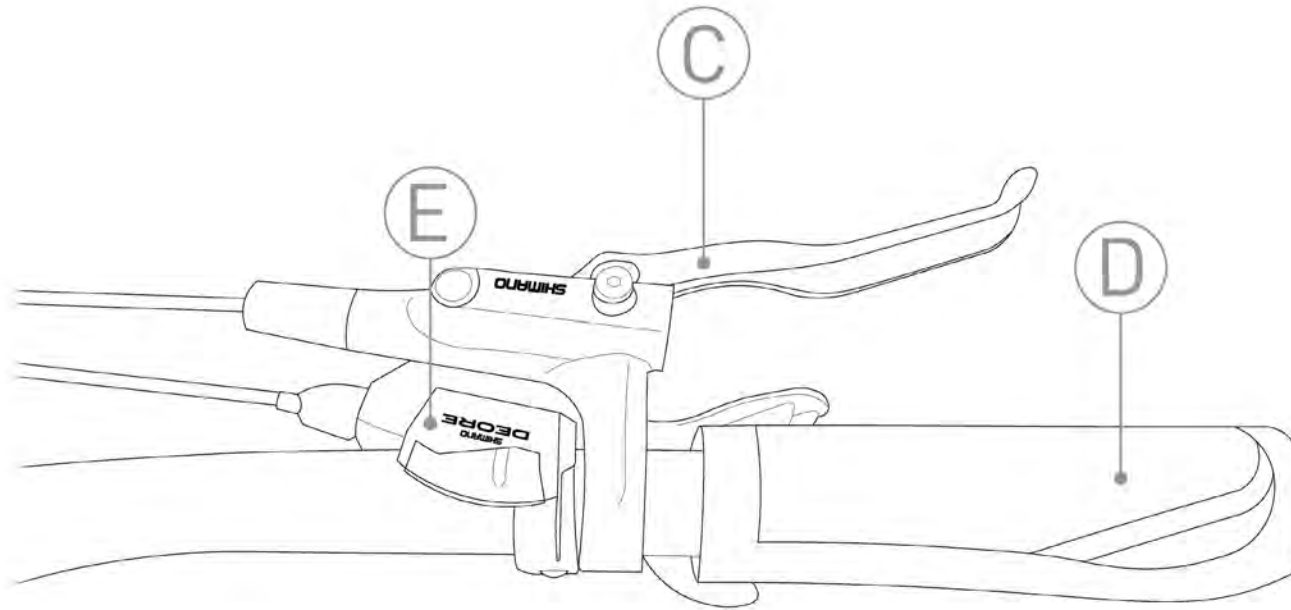

FIG. 3

3.5 Support system management

3.5.1 Support management commands

The pedal-assisted bicycle has, in the center of the handlebar, a display that allows you to manage the operation of the electric motor, in addition to other basic functions illustrated below. (Figure 4)

Near the left knob of the handlebar are 3 buttons, which can be used with a short or long press, thanks to these you can control the functionality of the display. (Figure 5)

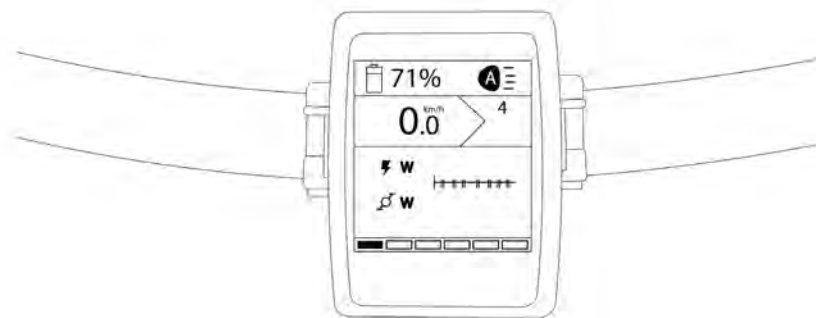

FIG. 4

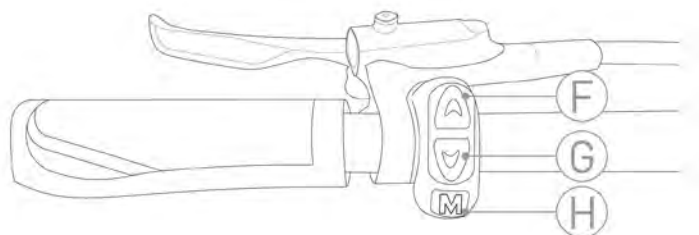

FIG. 5

button	Short pressure/ <1 second	prolonged pressure/ > 2 seconds
H-power	Allows you to: Scroll through the Home from one Main Screen to another; Scroll between Home and Menus; confirm the action during the changes.	Allows you to: Turn the display on and off; from the Menu and Advanced section, return to the last Home screen displayed.
F-up	Allows you to scroll through menu items, going up. allows you to increase the level of assistance.	from any main screen allows you to change the mode of operation of the lights.
G-down	allows you to scroll through menu items, going down. allows you to reduce the level of assistance.	from any main screen allows you to activate the Walk mode
F+G down+up	-	from the main screens, the simultaneous press of the two buttons, allows you to access the menu.

3.5.2 Turning the system on/off

To activate the system, press the "POWER" button (Ref.H - Figure 5) until the power diagram is displayed or press the "ON" button on the battery. To turn off the display, press and hold the "POWER" button until the power off screen appears or press the "OFF" button on the battery. If the E-Bike is not used for a variable time depending on the type of battery, the system will automatically turn off.



3.5.3. Activate support

The engine is activated, and is deactivated immediately if the pedaling ceases. The power of the engine depends on the force impressed on the pedals, according to a multiplicative factor depending on the level of assistance selected.

3.5.4 Setting the level of support

From any screen in the Home section you can change the level of assistance by pressing the "UP" key (Ref. F - Figure 5) to increase it and the "DOWN" key (Ref. G - Figure 5) to decrease it.

Multiplicative factor for each level of care:

LEVEL 0 - MULTIPLICATIVE FACTOR 0% (ENGINE NOT ACTIVE)

LEVEL 1 - MULTIPLICATIVE FACTOR 50%

LEVEL 2 - MULTIPLICATIVE FACTOR 100%

LEVEL 3 - MULTIPLICATIVE FACTOR 200%

LEVEL 4 - MULTIPLICATIVE FACTOR 300%

LEVEL 5 - MULTIPLICATIVE FACTOR 400%

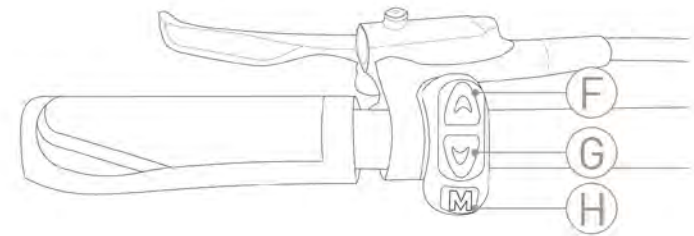

FIG. 5



ATTENTION

ATTENTION:

The engine has 5 levels of assistance that increase the power provided by the engine. If you put on 0 the engine is switched off.

3.6 Display graphic interface

After powering on, the first Distance screen of the home section appears. The Home section consists of 6 screens. To scroll through the screens, you need to press the "POWER" button.

From any screen in the home section, you can:

- > Adjust the level of assistance by pressing the "UP" and "DOWN" keys;
- > Enter the Walk mode, holding down the "DOWN" button;
- > Adjust the brightness of the eBike lights, holding down the "UP" button for 2";
- > Enter the Menu section, holding down the "UP"+"DOWN" keys at the same time for 2".

3.6.1. General screen composition

The screens in the Home section differ from each other in the type of information display. (Figure 4.1)

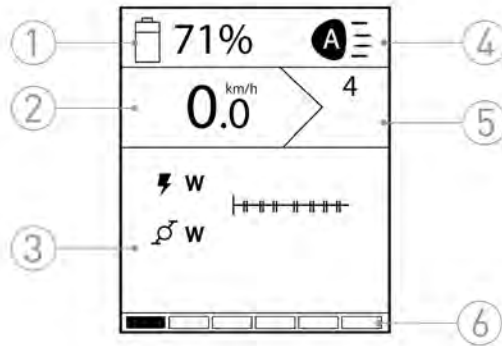

FIG. 4.1

1- BATTERY

-CHARGE STATUS PERCENTAGE.

2- E-BIKE CURRENT SPEED

IN KILOMETERS/HOUR (KM/H).

3- POWER GRAPHICS DISPLAY

-UPPER BAR: ENGINE POWER,
- LOWER BAR: CYCLIST POWER.

4- E-BIKE LIGHT ADJUSTMENT

AUTOMATIC/ON/OFF(RIF.3.7)

5- SERVICE LEVEL

(RIF. 3.5.4)

6- NAVIGATION BAR

PRESENT ON EACH SCREEN, INDICATES THE CURRENT SCREEN.



ENGINE POWER



CYCLIST POWER



DISTANCE TRAVELLED FROM THE START OF THE LAP



TIME ELAPSED SINCE THE START OF THE TOUR



PEDAL CADENCE



ENERGY BURNED BY THE CYCLIST



AVERAGE CONSUMPTION E-BIKE



TOTAL DISTANCE



TRAVELED AVERAGE SPEED



3.7 on-board computer mode

The on-board computer is able to adapt to different use scenarios, from switching to sports use. To move between the available display modes, briefly press the "POWER" button (Ref. H - Figure 5).

3.7.1. "RACE" mode

It is the fifth screen in the home section.

In this screen the values in watts (w) of the motor power and cyclist power are expressed in full. (Figure 4.2) This mode of use is addressed to experienced users, and to a sporty use of the e-bike. (Figure 4.2)

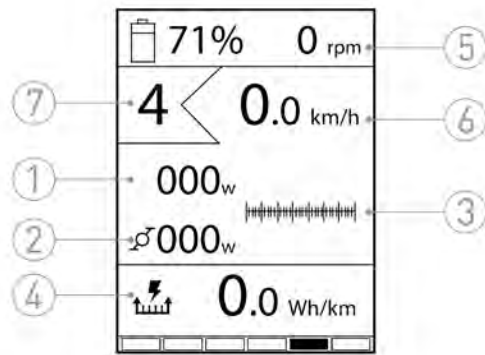



FIG. 4.2

1- POWER

 Indicates the instantaneous power delivered by the motor in watts (w).

2- CYCLIST POWER

 Indicates the instantaneous power expressed by the cyclist in watts (w).

3- POWER DISPLAY

 Graphic display of the upper bar power: engine power lower bar: cyclist power.

4- ENERGY CONSUMPTION

 Indicates the average energy consumption in watt-hours per kilometer (Wh/km), calculated since the last zeroing.

This data allows to adjust the level and five of the consumption of the eBike according to the need.

By calculating the ratio between this data and the capacity of the battery, the exact possible mileage data for each charge is obtained.

5- CADENCE

6- CURRENT SPEED

7- SERVICE LEVEL

$$\frac{\text{battery capacity}}{\text{average consumption}} = \text{Passable km}$$



3.7.2. Summary mode

It is the sixth screen of the Home section.

This screen summarizes the variable parameters of the previous screens. (Figure 4.3)



FIG. 4.3

- 1- INDICATES THE DISTANCE TRAVELED IN KILOMETERS (KM) SINCE THE LAST RESET.
- 2- INDICATES THE TIME SPENT IN MOTION SINCE THE LAST RESET. THE VALUE IS EXPRESSED IN HOURS: MINUTES: SECONDS.
- 3- INDICATES THE AVERAGE SPEED IN KILOMETERS PER HOUR (KM / H) DETECTED SINCE THE LAST RESET.
- 4- INDICATES THE AVERAGE ENERGY CONSUMPTION IN WATT-HOURS PER KILOMETER (WH / KM), CALCULATED SINCE THE LAST RESET.
- 5- INDICATES THE ENERGY CONSUMED BY THE CYCLIST IN KILOCALORIES (KCAL) SINCE THE LAST RESET.
- 6- INDICATES THE TOTAL DISTANCE TRAVELED BY THE EBIKE IN KILOMETERS (KM). NON-RESETTABLE VALUE.

3.8 Walking assistance mode

The system is equipped with a walking assistance function, which allows you to activate the engine up to a maximum speed of 6km/h to allow you to tackle more easily short stretches pushing the e-bike.

To activate the walk assistance function, press and hold the "DOWN" button (Ref. G in Figure 5). The engine will activate, and the appropriate warning will be displayed on the display. The engine will shut down in the following cases:

- Release of the "DOWN" button (Ref. G in Figure 5)
- Speed greater than 6km/h
- Locking the e-bike wheel

NOTE: By selecting the assistance level "0", the motor is completely disabled, and it is not possible to use the walking assistance function.



ATTENTION

Attention:
Walking assistance mode.
Before activating the walking assistance mode, hold the handlebars firmly in such a way as to avoid injuries.

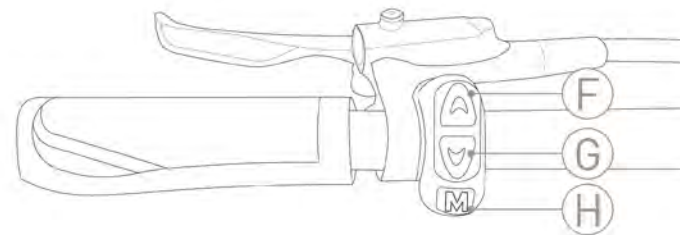

FIG. 5

3.9 Menu

By simultaneously pressing the "UP"+"DOWN" buttons (Ref. F - G - Figure 5) for two seconds you can open the menu screen. From any screen, by holding down the "POWER" button for 2", you can return to the last home screen displayed. Once inside you can move in the menu with the "UP" and "DOWN" buttons and press "POWER" as send.



ATTENTION

Attention:

Before pressing the F and G keys at the same time (Figure 5) position yourself firmly on the bike and apply the brake, so as not to unintentionally operate the departure from a standstill.

<u>MENU</u>
Reset trip
Advanced
System info
Battery info
Back

FIG. 4.4

RESET TRIP

THE RESET TRIP ITEM ALLOWS YOU TO RESET ALL THE RECORDED LAP DATA BRINGING THE COUNTERS BACK TO ZERO (0).

ADVANCED

SELECTING THIS FUNCTION, YOU ENTER THE ADVANCED SETTINGS MENU.

SYSTEM INFO

ON THIS SCREEN YOU CAN VIEW THE VERSIONS OF THE FIREWARE, THE INSTALLED HMI AND THE COMBINED ENGINE.

BATTERY INFO

BY SELECTING THIS FUNCTION, YOU CAN VIEW THE BATTERY INFORMATION.

BACK

SELECTING THIS FUNCTION RETURNS YOU TO THE HOME SCREEN.

Selecting the ADVANCED setting leads to the advanced settings menu, where you can change or control the essential parameters of the display. Specifically, you can change the brightness, language, unit, weight, gender and night mode.

<u>ADVANCED</u>
Brightness
Language
Unit
Weight
Gender
Night Mode
Back

FIG. 4.5



3.9.1. Screen brightness

From this screen you can adjust the brightness of the screen. Use the "UP" and "DOWN" keys to scroll through the values from 1 to 10. The selected value is highlighted in the center in the white row. (Figure 4.6)

<u>BRIGHTNESS</u>
4
5
6
7
8

FIG. 4.6

3.9.2. Change language

From this screen you can choose the language of the texts of the unit. Use the "UP" and "DOWN" keys to scroll through the available items. The selected value is highlighted in the center in the white row. (Figure 4.7)

<u>LANGUAGE</u>
Italiano
English
Français
Deutsch
Español

FIG. 4.7

8.9.3 Units of measurement

From this screen you can select the unit of measurement with which they are calculated:

- > Instantaneous speed,
- > Average speed,
- > Average consumption,
- > Lap distance,
- > Total distance.

Use the "UP" and "DOWN" keys to scroll through the Entries Available. The value selected è Highlighted per center in ruler white woman. (Figure 4.8)

<u>UNIT</u>
Km
Miles
Back

FIG. 4.8



8.9.4 Weight

From this screen you can set your body weight by choosing a value between 50 and 150 kg. Setting this data is not necessary for the proper functioning of the eBike. The value has the sole purpose of making the calculation of calories consumed reliable.

Use the up and down keys to scroll through the available items. The selected value is highlighted in the center in the white line. (Figure 4.9)

<u>WEIGHT</u>
68
69
70
71
72

FIG. 4.9

8.9.5 Gender

From this screen you can set your gender. Setting this data is not necessary for the proper functioning of the eBike. The value has the sole purpose of making the calculation of calories consumed reliable.

Use the up and down keys to scroll through the available items. The selected value is highlighted in the center in the white row. (Figure 4.10)

<u>GENDER</u>
Male
Female
Back

FIG. 4.10

ERROR CODE

In the event of an anomaly, the system reports the problem to the user by displaying a danger icon combined with a 4-character code, which allows you to trace the type of error.

In base per type of anomaly the system could prevent activation of engine or do work a power redoubt. Where è Suitable "do request of assistance", è necessary the intervention of a technician specialized OILS eBike Systems.

ANOMALY CODE	DESCRIPTION
0001	PROBLEM COMMUNICATING WITH BATTERY. BATTERY STATUS DATA MAY BE DISPLAYED INACCURATELY. CHECK THAT THE WIRING AND CONTACTS OF THE BATTERY ARE CONNECTED CORRECTLY AND INTACT.
0101	COMMUNICATION PROBLEM BETWEEN DRIVE AND HMI. CHECK THAT THE WIRING IS CONNECTED CORRECTLY AND INTACT.
0104	SPEED SENSOR NOT DETECTED. CHECK THAT THE ALIGNMENT BETWEEN THE MAGNET AND THE SPEED SENSOR IS CORRECT. CHECK THAT THE SPEED SENSOR IS INSTALLED AND CONNECTED CORRECTLY.
0105	NON-COMPLIANT TORQUE TRANSDUCER SIGNAL. THE TORQUE TRANSDUCER SIGNAL HAS AN ANOMALY. LOW POWER OPERATION.
0106	OFFSET TORQUE TRANSDUCER NOT COMPLIANT. THE TORQUE TRANSDUCER SIGNAL HAS AN ANOMALY.
0801	ANOMALY TO MOTOR ROTATION SENSORS.
0802	PEDAL ROTATION SENSOR ANOMALY.
0804	EXCESSIVE DRIVE TEMPERATURE. THE TEMPERATURE SENSOR HAS DETECTED A TEMPERATURE ABOVE THE THRESHOLD OF DANGER.
0805	EXCESSIVE ENGINE TEMPERATURE. THE ENGINE HAS REACHED A TEMPERATURE ABOVE THE DANGER THRESHOLD.
0806	NON-COMPLIANT PERIPHERAL BUS VOLTAGE.
808	LOCKED ROTORS. THE ENGINE FAILED TO START DUE TO A MECHANICAL BLOCKAGE OR A PROBLEM WITH THE INTERNAL WIRING OF THE DRIVE UNIT.
0809	THE BATTERY VOLTAGE IS HIGHER THAN THE MAXIMUM ALLOWED.
0810	NON-COMPLIANT CURRENT SENSOR SIGNAL.
0811	THE DRIVE DETECTED AN OVERCURRENT.
1101	COMMUNICATION PROBLEM BETWEEN HMI AND DRIVE. CHECK THAT THE WIRING IS CONNECTED CORRECTLY AND INTACT.
1102	A BUTTON PANEL IS LOCKED IN THE PRESSURE POSITION.



3.9 Error display

In the event of an anomaly, the system reports the problem to the user by displaying a danger icon, together with a 4-character code that allows you to trace the type of problem.

NOTE: Depending on the type of anomaly, in order to ensure safety, the system may prevent the engine from activating, or operate in a low-power safety mode..

3.10 Troubleshooting

PROBLEM	CAUSE/SOLUTION
THE SYSTEM DOES NOT TURN ON	CHECK THAT THE BATTERY IS PROPERLY INSERTED IN PLACE, AND THAT IT IS CHARGED.
SUPPORT DOES NOT ACTIVATE	CHECK THAT THE SELECTED LEVEL OF ASSISTANCE IS GREATER THAN 0, AND THAT THE LEVEL OF CARI-BATTERY APPROX IS SUFFICIENT.
THE DISPLAY DISPLAYS AN ERROR MESSAGE	THE SYSTEM DETECTED AN ANOMALY. DEPENDING ON THE TYPE OF ANOMALY, THE ENGINE MAY BE DEACTIVATED OR OPERATE AT REDUCED POWER. FOR MORE DETAILS REFER TO CHAPTER 3.10.
THE DISPLAY GLASS IS FOGGED	FOLLOWING SUDDEN CHANGES IN ENVIRONMENTAL CONDITIONS, CONDENSATION IS POSSIBLE INSIDE THE GLASS. CONDENSATE WILL DISAPPEAR AS A RESULT OF TEMPERATURE STABILIZATION.



3.11 Battery

The bicycle provides pedaling assistance by means of an electric motor powered by the battery placed in the down tube of the frame structure (Figure 6)

3.11.1 Battery charge status

You can view the battery charge status directly on the assistance system management display.

In the event that the battery is disassembled from the vehicle or you want to see the state of charge without turning on the assistance system, at the bottom of the battery there is a button (Ref. I - Figure 6) that allows, through 5 LED lights (Ref. L - Figure 6), to display the charge status.

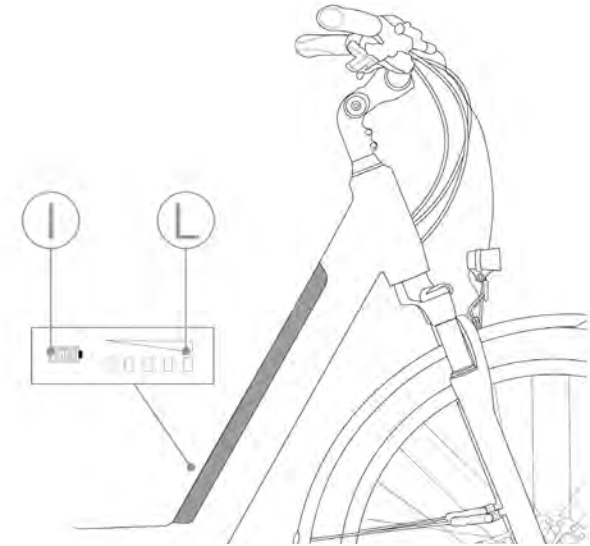

FIG. 6

3.11.2 Battery removal/installation

- 1- To remove the battery, make sure the assistance system is turned off and do the following:
- 2- Insert the battery lock/unlock key into the appropriate lock at the top left of the frame, near the handlebar and turn the keys counterclockwise (Ref.M - Figure 7);
- 3- Holding the key rotated, unhook the battery and lift it (Ref.2 - Figure 7). 3- Take out the battery completely taking care not to bump into the frame.



FIG. 7

To install the battery, proceed as follows:

1- This procedure should be done without the unlock key, remove it if inserted.

2- Align the battery above the oblique pipe of the frame by first matching the electrical connector (Ref. N - Figure 8).

3- Carefully insert the battery into the frame until you hear the closing click of the lock. At this point the battery is already automatically locked.



FIG. 8

3.11.3 Battery charging

Charging the battery of the pedal-assisted bicycle can only be done by removing the battery .
To charge the battery proceed as follows:

1. Turn off the assistance system of the pedal-assisted bicycle using the appropriate "MODE" button (Ref. H in Figure
2. Remove the battery;
3. Connect the supplied battery charger to the socket with the appropriate plug, at the bottom of the battery;
4. Connect the battery charger to a power outlet (230 V / 50 Hz) and charge the battery for as long as necessary.

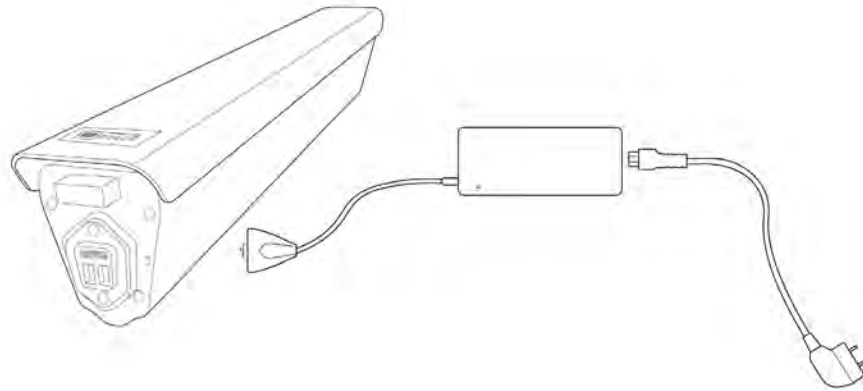

FIG. 9



ATTENTION

CHARGER

Always connect the plug to the battery first and then the battery charger to the power outlet.

3.11.4 Troubleshooting

PROBLEM	CAUSE/SOLUTION
The system does not turn on	Check that the battery is charged.
PROBLEM	CAUSE/SOLUTION
The assistance is not activated	Check that the battery charge level is sufficient.



ATTENTION

TROUBLESHOOTING

In the event that the assistance system does not activate even if the battery is charged, contact your authorized dealer.



3.12 Front and rear headlight

To ensure visibility both during the day and at night, two headlights are installed, one front and one rear. These devices are operated by means of the control device of the assistance system during the use of the pedal-assisted bicycle.



FIG. 10



FIG. 11

3.13 Front suspension

The pedal-assisted bicycle is equipped with a front suspension system that allows you to dampen the stresses caused by the roughness of the route. The suspension model is adjustable by means of special adjustment controls in the upper part of the fork.

In particular, the blue manettino positioned at the top right (Ref. 0 - Figure 12), allows you to block the compression, effectively transforming the suspension from cushioned to rigid.

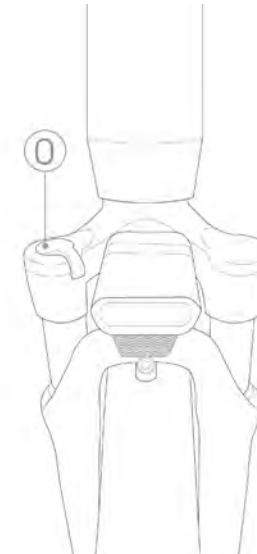

FIG. 12

4. CONDITIONS OF USE AND INTENDED ENVIRONMENTS

4.1 Intended use

The pedal-assisted bicycle is designed and built to be used outdoors, on roads and private or public environments. In particular, the components and the type of pedal-assisted bicycle, allow you to face routes with asphalt surfaces or with similar characteristics without particular roughness.

Any change in the state of construction can compromise the behavior, safety and stability of the pedal-assisted bicycle and can lead to an accident.

Other types of use, or the extension of the use beyond that envisaged, do not correspond to the intended purpose assigned by the manufacturer, and therefore the same cannot assume any responsibility for any damage that may result.

4.2 Environment of use

The pedal-assisted bicycle can be used outdoors, in the absence of adverse weather conditions (rain, hail, snow, strong wind, etc.):

- Maximum permissible temperature: +40 °C
- Minimum permissible temperature: 0 °C
- Maximum permissible humidity: 70 %

The environment of use may have an asphalted bottom or with not excessively high roughness.

In addition, the place of use must be illuminated, by the sun or by artificial lights, in such a way as to guarantee the correct vision of the route and the controls of the pedal-assisted bicycle (recommended from 300 to 500 lux). The pedal-assisted bicycle can be equipped with a white front light and red light rear torch.

PROHIBITED USE ENVIRONMENTS

The pedal-assisted bicycle must not be used:

- **In areas subject to risk of fire or explosion;**
- **In environments with corrosive and/or chemically active atmosphere;**
- **in poorly lit environments;**
- **On excessively inaccessible terrain, given the characteristics of the same (frame, wheels etc.);**
- **In enclosed spaces, if they do not allow safe use;**
- **In dark environments.**



ATTENTION



4.3 Improper uses and contraindications

The actions described below, which obviously cannot cover the entire range of potential possibilities of "misuse" of the pedal-assisted bicycle, are to be considered absolutely Prohibited.



ATTENTION

PROHIBITED OPERATIONS

- **The execution of prohibited operations invalidates the warranty.**
- **The manufacturer declines all responsibility for any damage to property and persons resulting from the execution of prohibited operations.**



DANGER

ABSOLUTELY FORBIDDEN

- **Ride the pedal-assisted bicycle for uses other than those for which it was built, i.e., the pleasure of A passenger.**
- **Ride the pedal-assisted bicycle in areas where there is a danger of explosions.**
- **Ride the pedal-assisted bicycle in the presence of adverse weather conditions (heavy rain, hail, snow, strong wind, etc.).**
- **Carry a passenger in addition to the driver.**
- **Ride the pedal-assisted bicycle under the influence of alcohol or drugs.**
- **Ride the pedal-assisted bicycle if your weight is higher than allowed.**
- **Charge the battery in an environment that is too hot or not sufficiently ventilated.**
- **Cover the battery while charging.**
- **Smoke or use open flame near the charging area.**
- **Perform any maintenance with the battery connected.**
- **Use non-original spare parts.**
- **Insert your limbs or fingers between the moving parts of the bicycle.**
- **Use the bicycle on Land asphalt o Dirt roads with hurdles Higher a How much permission from middle.**



5. LIFTING AND TRANSPORT

5.1 Lifting

The weight of the pedal-assisted bicycle model E-SINOPE is such that it can be lifted and transported by a person, also because of the overall dimensions.

The optimal solution to perform the movement is to grab a handlebar knob and the back of the saddle.



DANGER

CRUSHING AND IMPACT

- **During lifting, extreme caution should be exercised to avoid damage to people and property.**
- **This operation must be performed by robust people.**

The manufacturer is not liable for breakages due to lifting and/or transporting the pedal-assisted bicycle after delivery.

5.2 Transport

To ensure the safety of transport on vans it is necessary to prevent the movement of the pedal-assisted bicycle. This is achieved by binding it with bands or anchor cables in good condition.

In this regard, coupling devices must be installed so as not to damage the frame and other parts of the bicycle.



DANGER

RISK OF ACCIDENTS

- **ALWAYS make sure that the adjustment screws of the frame and handlebars are tightly tightened before each use of the bike. Otherwise, accidents, even serious ones, could result**



6. COMMISSIONING

6.1 Battery charge

Before using the bike for the first time you must charge the battery for at least 8 hours, using the appropriate battery charger, supplied.

The pedal-assisted bicycle, model E-SINOPE, is equipped with an electric motor powered by a 36-ion lithium-ion battery V. The battery pack is housed in the central part of the frame, inside the lower tube. The average charging time varies from 4 to 6 hours.

The charging operation can be carried out in a well-ventilated box with the battery installed on the bicycle. To charge the battery proceed as in clause 3.11.3.

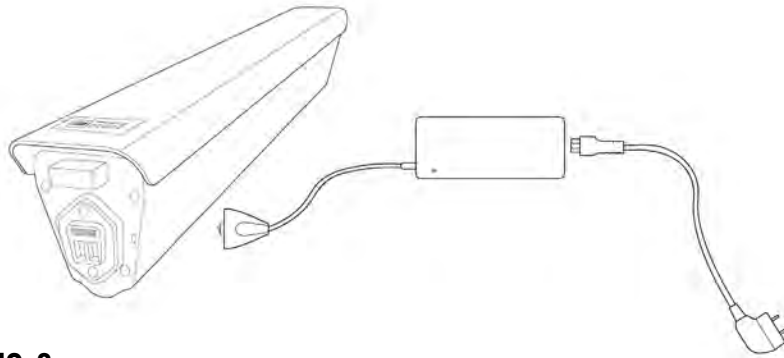

FIG. 9



ATTENTION

CHARGER

Always connect the plug to the battery first and then the battery charger to the power outlet.



ATTENTION

BATTERY CHARGE

The battery should not be completely discharged to preserve its life and not run the risk of damaging it. In any case, the same must be recharged at least every 3 months even in case of non-use of the bicycle.



DANGER

PRECAUTIONS WHEN CHARGING

- **Always connect the plug to the battery and then the power plug to the mains.**
- **When charging is complete, always disconnect the plug from the mains first and then the plug from the battery.**
- **Always recharge the battery completely.**
- **Always use the original power supply that came with it.**
- **Do not leave the battery charging for more than 8 hours.**
- **Always recharge in a ventilated environment.**
- **Do not recharge the battery in too hot environments.**
- **Do not recharge the battery in the vicinity of flammable liquids.**
- **Do not cover the battery in any way while charging.**
- **If the battery smells bad, immediately unplug from the mains and ventilate the room, do not touch the battery.**



6.2 Preliminary functional checks

Before each use, the driver must ensure the safety status of the pedal-assisted bicycle. Therefore, perform the following inspections before riding the pedal-assisted bicycle.

6.2.1 Control devices

Check the efficiency and state of charge of the battery. Use in a very cold environment quickly degrades battery efficiency. Check the tension and lubrication of the chain.

6.2.2 Wheels

Check the inflation pressure of the tires. Check the state of wear of the tread: there must be no cuts, cracks, foreign bodies, abnormal bulges, visible canvases and other damage.



Do not inflate the tyres beyond the permissible value reported by the costuttore in the side surface of the same.

ATTENTION

6.2.3 Braking system

Perform a visual inspection of the braking system verifying that there are no damaged cables or lubricants in the brake and rim braking surfaces. Check the operation of the brakes with a low-speed braking test in an obstacle-free area, first with the rear brake and then with the front brake. Test the efficiency of the braking system on a flat and low-speed route.



NEGATIVE VERIFICATION

In the event that, during the preliminary checks, defects of any kind should be found and even a single verification is negative, DO NOT RIDE THE PEDAL-ASSISTED BICYCLE. Immediately activate all measures to carry out a proper repair and, if necessary, contact the authorized dealer or an authorized workshop.

ATTENTION



6.2.4 Frame and saddle position

Check that the frame and saddle are fixed correctly and positioned in the most comfortable configuration for the rider for complete control of the bike. Otherwise, before departure, act on the position and saddle adjustment systems. For more information on the regulation refer to section 2.6.

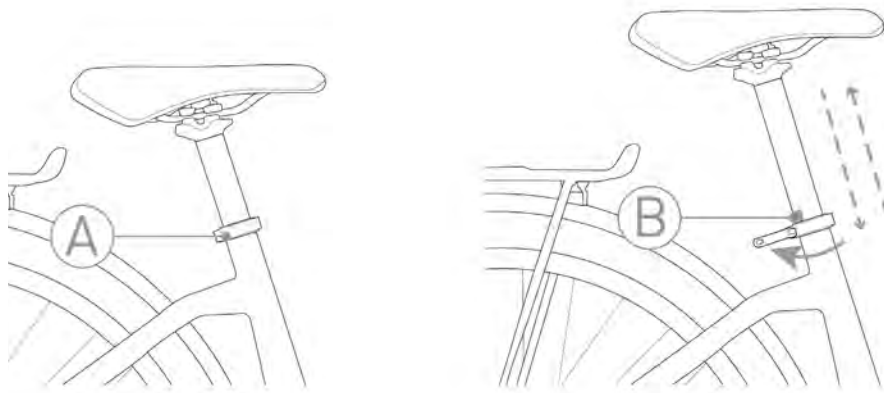

FIG. 1



IMPORTANT WARNING:
Check that the minimum insertion mark (B) is not visible.



FRAME POSITION

it is strictly forbidden to use the bicycle without having correctly fixed all the parts of the bicycle that had folded and without having assumed a comfortable and safe riding position.

6.2.5 Brakes adjustment

Before using the pedal-assisted bicycle, adjust the position of the brake levers on the handlebars to obtain a comfortable and firm grip of the lever and knob during braking. Loosen the screw (Ref. P - Figure 13) and rotate the brake lever to the desiderata position. Check that you have tightened the screw correctly before using the pedal-assisted bicycle.

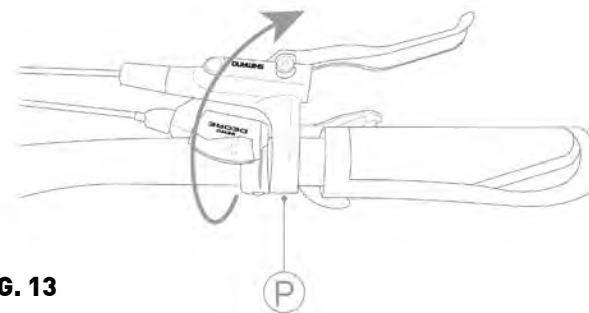

FIG. 13

6.2.6 Suspension adjustment

At this point adjust the suspension to make the use of the pedal-assisted bicycle more comfortable.

Depending on the path it is possible, by rotating the blue manettino positioned at the top right (Ref. O - Figure 12), to block the compression, effectively transforming the fork from cushioned to rigid.

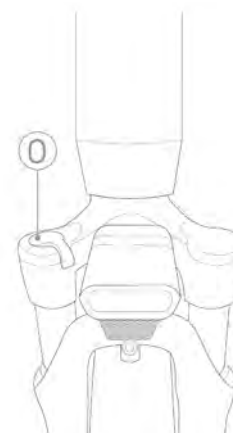

FIG. 12

6.2.7 Headlight operation

Before using the pedal-assisted bicycle, check the operation of the front and rear lights (Figures 10-11) by activating the on/off button on the display. For further information please refer to section 3.9.



FIG. 10



FIG. 11



DANGER

ADJUSTMENT

It is strictly forbidden to regulate the devices of the bicycle if you are not an experienced and educated person to do so. Incorrect regulation can lead to serious injuries. Therefore, if you are not able to regulate these functions, contact specialized personnel.

The manufacturer is not liable for accidents resulting from incorrect regulation of the devices of the pedal-assisted bicycle.

7. USE OF THE BICYCLE

The pedal-assisted bicycle has been designed and built for use in open places, with asphalt bottom or similar, for amateur use.

- It is forbidden to load a passenger in addition to the driver.
- It can only be used by experienced adults and children.
- The use of the pedal-assisted bicycle is not recommended for pregnant women.
- Do not take alcohol or drugs before riding the pedal-assisted bicycle.
- Don't ask your pedal-assisted bike for performance that's superior to what it was designed for. Use the bicycle only in the manner and intended uses described in this manual.
- Never ride the pedal-assisted bicycle with disassembled parts.
- The pedal-assisted bicycle cannot be used on very wet, icy or slippery surfaces.
- Avoid very uneven surfaces and obstacles.
- Ride with both hands on the handlebars.
- Replace worn and/or damaged parts. Possibly, if necessary, have it checked by authorized personnel.

Before leaving, carry out all the checks reported in the previous chapter and always keep focused while driving, for your own safety and that of others.



DANGER

DANGER OF ACCIDENTS

- **Verify that all commands are fully functional.**
- **Always respect the highway code.**
- **Use the appropriate protective equipment (helmet, etc ..)**



7.1 Use of the bicycle

Before using the pedal-assisted bicycle in places open to traffic, it is advisable to familiarize yourself with the behavior of the vehicle.

The first uses must be made in private environments away from traffic, other cyclists or obstacles of any kind.

The driver must adapt the driving speed of the pedal-assisted bicycle to the conditions of the route and the presence of other vehicles or pedestrians. Especially when facing curves, you have to keep a moderate speed (the smaller the curve radius, the lower the speed). When the driver stops pedaling or the speed reaches 25 km/h, the electric motor no longer provides assistance and the bicycle proceeds completely managed by the Pedals.

It is essential to gain experience in driving the pedal-assisted bicycle, before proceeding at a high speed. In case you do not want to use the motor, simply remove the battery or set the lower level of assistance.

7.2 Braking

To minimize the stopping distances of the vehicle it is necessary to suddenly stop pedaling and subsequently apply braking force gradually so as not to destabilize the middle.

Encourage the use of the rear brake under braking to stabilize the bicycle.



ATTENTION

DRIVING CONDUCT

Excessive braking force can trigger harmful phenomena such as locking the wheel or overturning the vehicle. It is very dangerous to brake when cornering: you may lose control of the bike.

7.3 Bicycle parking

The bicycle is not equipped with a stand for lateral sustenance, therefore, before abandoning the bicycle, check that the pedal-assisted bicycle is supported on stable ground and that remains in a stable position.

The bicycle must be parked in the prepared parking areas and, in any case, without obstructing the passage paths, emergency exits, electrical panels and workstations antifire.



8. MAINTENANCE

8.1 General



DANGER

DANGER OF ACCIDENTS

During all maintenance work, follow the appropriate safety measures. All maintenance operations must be carried out with the battery disconnected from the pedal-assisted bicycle and the battery charger and the bicycle resting in a stable manner, taking advantage of special support elements.

To maintain the full functionality of your pedal-assisted bicycle for a long time, it is necessary to carry out maintenance as prescribed, with correctness and professional skills.

After each ordinary maintenance intervention, a check on the perfect functioning of all the controls is mandatory.

8.2 Daily maintenance and checks

8.2.1 Control of nameplates and pictograms

Check the legibility and presence of the CE plate, and the warning stickers applied to the body of the bicycle.

8.2.2 Wheel control

Through the special inflation valve on the rims, check the inflation pressure of the tires using a compressor and a gun with pressure gauge, or a pump. Check the status of the tread, the rim and the attachment of the rims to the hubs. In case of tyre replacement, please contact your authorised dealer or a qualified tyre dealer.



ATTENTION

Do not inflate tyres beyond the permissible value reported by the rider on the side surface of the tyres.

8.2.3 Brake operation control

The brakes must be adjusted in such a way as to ensure effective braking and at the same time the control levers must have an adequate stroke, in order to modulate the braking: in other words, the brakes must not be too slow or too pulled. Check that brake system discs and pads are not contaminated with oils or soaps. Check the effectiveness of the braking system on flat terrain and at low speeds. Check annually the wear of the brake pads by going to authorized personnel.

Precision brake adjustment

Brake adjustment should only be carried out by authorized personnel.



8.3 Weekly maintenance and checks

8.3.1 Washing and cleaning

The cleaning of the pedal-assisted bicycle is not only a matter of decorum, but also allows you to immediately detect a possible defect in the same.

In order not to damage or compromise the operation of the various components, especially the electrical parts, cleaning must be carried out taking some precautions. It is absolutely forbidden to direct jets of pressurized water to the electrical parts, the motor and the battery, for which sponge washing is recommended.

Before starting the pedal-assisted bicycle, dry completely with low-pressure compressed air and check that there is no residual moisture left on the electrical components.

8.3.2 Lubrication and chain tension control

It is important to periodically clean and lubricate the chain to avoid corrosion due to atmospheric agents.

1. Wipe the entire length of the meshes with a rag.
2. Spray on all meshes a special grease in spray for transmission chains.

Check the correct tension of the chain by placing the gearbox in the two different extreme positions allowed by the pinion pack.



CORRECT CHAIN LIBRICATION

Be extremely careful not to let the lubricant go on the brakes or tires of the bicycle, This can lead to the occurrence of serious injuries!!

8.3.3 Frame and bolt control

The load-bearing frame of the pedal-assisted bicycle and the welds must be free of visible defects such as: cracks, deformations, incisions, corrosions, etc.

Secure who everybody Bolts of bicycle a foot thrust Assisted Are well Tightened.



8.4 Monthly maintenance and checks

8.4.1 Control of electrical circuits and components

Check the condition and fixing of the battery cables: the sheaths of the electrical cables must be in good condition and the terminals must be tight, not corroded and covered with insulating grease.

Check that all light bulbs and lights have been switched on correctly.

8.4.1 Control and adjustment of the rear derailleur

Adjustment of the lower and upper limit switches of the gearbox: Turn the two screws (Ref. Q -R - Figure 14) so that the chain does not come out. The chain displacement device must be in line with both the larger and smaller gear. (Figure 15)

Lower limit adjustment

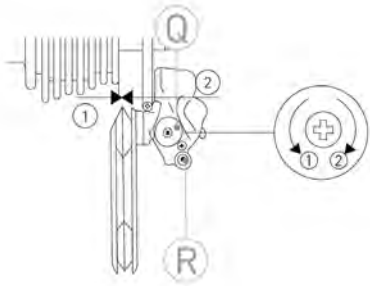

FIG. 14

Upper limit adjustment

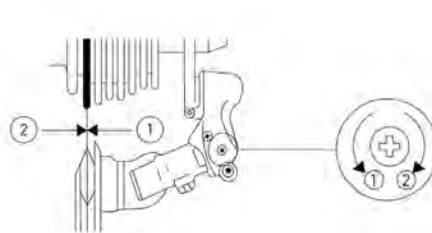

FIG. 15

Adjust the tension of the cable by acting on the appropriate control to ensure the immediate response of the rear derailleur to the control of the handlebar. (Figure 16)

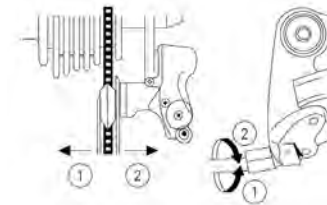

FIG. 16

To prevent damage to the gearbox, it is recommended not to exert too much pressure on the pedals while changing gear. So, avoid changing when making an effort or driving on a slope.

9. TECHNICAL SUPPORT AND SPARE PARTS

If you need technical assistance, please contact your authorized dealer.
In case of assembly of non-original parts, the warranty loses its validity!



ATTENTION

ORIGINAL SPARE PARTS

The manufacturer is exempt from any liability for damages of any kind, generated by the use of non-original spare parts.

10. WAREHOUSE

In the event that the pedal-assisted bicycle should be stored and stored for long periods of inactivity, the following operations must be carried out:

- Repair it in a dry and airy place.
- Perform a general cleaning of the pedal-assisted bicycle.
- Remove the battery from the seat and store it in the appropriate storage site (fully charged and recharge it regularly).
- Leave the bike on a special support.
- Protect exposed electrical contacts with antioxidant products.
- Fatten all the surfaces Not Protected from paints o Treatments anticorrosion.



11. DISPOSAL OF COMPONENTS AND MATERIALS



ATTENTION

DISPOSAL OF MATERIALS

The disposal of packaging, waste and vacuumed dust, of the replaced parts, of the pedal-assisted bicycle as a whole at the end of its expected life, must be carried out in respect of the environment; avoiding polluting soil, water and air respecting in any case the national and local legislation in force on the subject.

Indications for waste treatment:

- Ferrous materials, aluminum, copper: these are recyclable materials to be given to a special authorized collection center.
- Plastic materials, fiberglass, gaskets, tires: these are materials to be sent to landfills or recycling centers.
- Batteries must be taken to authorized disposal centers.

Divide the materials according to their nature, commissioning specialized companies authorized to dispose of, in compliance with the provisions of the law.

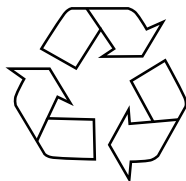

12. WARRANTY RULES

MBM srl guarantees that its bicycles are free from any manufacturing defect or invoice. This guarantee covers the repair or replacement of any part recognized as defective, subject to the following conditions.

TERMS AND CONDITIONS

- **Warranty period:** the pedal-assisted bicycle is guaranteed for 24 months on mechanical and electrical parts, except for batteries and all components subject to wear. The batteries are covered by a conditional warranty for 24 months and limited to proper use of the same:

- first 6 months 100% coverage;
- from the 7th to the 12th month 50% coverage;
- from the 13th to the 24th month coverage of 25%;

If the battery has been left to discharge below the allowed, the manufacturer is not responsible for any damage.

- In order to make this warranty operational, you must fill out the online form which is accessed by QR CODE or by binding directly to the site warranty.mbmbike.it no later than 15 days from the date of purchase of the bicycle. You will need the serial number and the photograph of the proof of purchase of the authorized retailer. The serial number is printed on the plate applied on the straight tube of the bicycle at the bottom bracket.

- Claims must be made through an official retailer by presenting the original tax document (receipt or invoice) and printing of the confirmation of activation of the warranty that you will receive gradually e-mail after filling out the online form.

- The warranty provides for the free replacement of any defective or prematurely worn part provided that all the requirements have been complied with and the improper use of the bicycle is not found. The manufacturer's obligations are limited to the replacement of defective parts.

- Finally, our Technical Department will decide whether or not the defective part or bicycle falls within the conditions of this warranty.

- This warranty does not cover in any way the replacement of worn parts from normal use of the bicycle.

- This warranty does not apply in any case to breakdowns or damage caused by improper use of the bicycle, use of the bicycle for sports competitions, from the application of non-original accessories, or from improper interventions of maintenance.



FIG. 17



**ACTIVE HERE
WARRANTY**

EXCLUSIONS

Normal wear and tear on parts subject to it, such as tires, chains, brakes, cables and gear wheels in situations where there are no groups or material defects.

- Bicycles assisted by an unauthorized MBM distributor.
- Changes from the original packaging.
- Use of the bike for abnormal activities, such as competition and/or commercial activities, or for purposes other than those for which the bike was designed.
- Damage caused by non-compliance with the user manual.
- They give paints and decals as a result of exposing the bike or using it in harsh conditions and climates.
- Labor costs for the replacement of parts.
- Transport costs.

Except as provided in this warranty and subject to all other warranties, MBM and its employees and agents shall not be liable for any loss or damage of any kind (including incidental and consequential losses or damage caused by negligence or failure) arising out of or relating to any MBM bicycle.

The M.B.M. S.r.l. does not assume responsibility for damage to things and people, due to improper use of the vehicle.

13. CONFORMITY

Hybrid-powered bicycles with a maximum support speed of 25km/h meet the requirements:

- 2006/42/EC Machinery Directive
- 2014/30/EU Electromagnetic Compatibility Directive
- 2011/65/EU Rohs Directive

These bicycles also comply with the following non-harmonized standards:

- Bicycles Electric: EN 15194

Disclaimer

It is strongly recommended not to remove or replace any original equipment or to modify the bicycle in any way that may change the design and/or operation. Such modifications could seriously damage the handling, stability and other aspects of the bike, making it unsafe. The removal or modification of parts, or the use of non-original equipment as spare parts, may make the bike no longer comply with applicable rules and laws. To ensure safety, quality and reliability, use only original parts or MBM authorized spare parts for repair and replacement.





M.B.M. Srl

Via Emilia Levante, 1671/73/75 | 47521 Cesena (FC)

Tel.: + 39 0547 -300364

Fax: +39 0547-304326

Email: info@mbmbike.it



W W W . M B M B I K E . I T